



FX3U-232ADP

Installation Manual



Manual Number	JY997D13701
Revision	F
Date	September 2008

This manual describes the part names, dimensions, mounting, and specifications of the product. Before use, read this manual and the manuals of all relevant products fully to acquire proficiency in handling and operating the product. Make sure to learn all the product information, safety information, and precautions.

Store this manual in a safe place so that it can be taken out and read whenever necessary. Always forward it to the end user.

Registration: The company and product names described in this manual are registered trademarks or the trademarks of their respective companies.

Effective September 2008
Specifications are subject to change without notice.

© 2005 Mitsubishi Electric Corporation

Safety Precaution (Read these precautions before use.)

This manual classifies the safety precautions into two categories:

⚠ DANGER and ⚠ CAUTION.

DANGER	Indicates that incorrect handling may cause hazardous conditions, resulting in death or severe injury.
CAUTION	Indicates that incorrect handling may cause hazardous conditions, resulting in medium or slight personal injury or physical damage.

Depending on the circumstances, procedures indicated by ⚠ CAUTION may also cause severe injury. It is important to follow all precautions for personal safety.

Associated Manuals

Manual name	Manual No.	Description
FX3G Series User's Manual - Hardware Edition	JY997D31301 MODEL CODE: 09R521	Explains the FX3G Series PLC specifications for I/O, wiring, installation, and maintenance.
FX3U Series User's Manual - Hardware Edition	JY997D16501 MODEL CODE: 09R516	Explains the FX3U Series PLC specifications for I/O, wiring, installation, and maintenance.
FX3UC Series User's Manual - Hardware Edition	JY997D28701 MODEL CODE: 09R519	Explains the FX3UC Series PLC specifications for I/O, wiring, installation, and maintenance.
FX3G/FX3U/FX3UC Series Programming Manual - Basic & Applied Instruction Edition	JY997D16601 MODEL CODE: 09R517	Describes PLC programming for basic/applied instructions and devices.
FX Series User's Manual - Data Communication Edition	JY997D16901 MODEL CODE: 09R715	Explains N:N network, Parallel Link, Computer Link, Non-Protocol communication by RS and RS2 instructions/FX2N-232IF.

How to obtain manuals

For product manuals or documents, consult with the Mitsubishi Electric dealer from who you purchased your product.

Applicable standards

FX3U-232ADP units made in June, 2005 or later comply with the EC Directive (EMC Directive) and UL standards (UL, cUL). Further information can be found in the following manual.

- Refer to the FX3G Series Hardware Manual (Manual No. JY997D33401)
- Refer to the FX3U Series Hardware Manual (Manual No. JY997D18801)
- Refer to the FX3UC (D, DSS) Series Hardware Manual (Manual No. JY997D28601)

→ Refer to the FX3UC-32MT-LT-2 Hardware Manual (Manual No. JY997D31601)

Regarding the standards that relate to the main unit, please refer to either the FX series product catalog or consult with your nearest Mitsubishi product provider.

1. Outline

The FX3U-232ADP communication special adapter (hereinafter called 232ADP) is a special adapter for RS-232C communication with a 9-pin D-Sub connector. The 232ADP is an isolated signal exchange unit used for RS-232C serial data communication between the PLC and an RS-232C device.

1.1 Communication Function

Communication type	Function
Computer link	Data transfer between the PLC and computer (specified as the master station) via dedicated protocol.
Non-protocol communication	Serial communication between the PLC and an RS-232C device via non-protocol.
Programming communication	Program transfer or monitoring enabled via the serial port of the 232ADP.
Remote maintenance	Program transfer or monitoring enabled via modem and phone line connected to the serial port of the 232ADP.

1.2 Incorporated Items

Verify that the following product and items are included in the package:

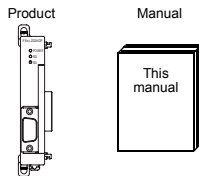

1.3 External Dimensions, Part Names, and Pin Configuration

1.3.1 External Dimensions and part names

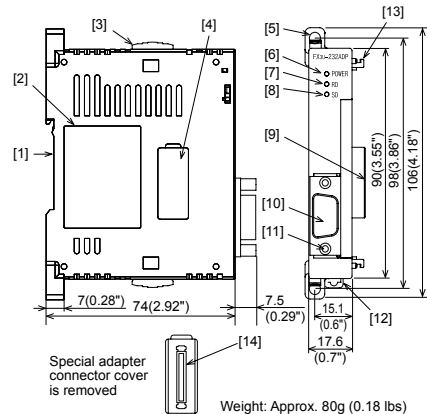

Weight: Approx. 80g (0.18 lbs)

- [1] DIN rail mounting groove (DIN rail: DIN46277)
- [2] Name plate
- [3] Special adapter slide lock: Used to connect additional special adapters onto the left side of this special adapter.

- [4] Special adapter connector cover: Remove this cover to connect additional special adapters to the left side.
- [5] Direct mounting hole: 2 holes of $\phi 4.5$ (0.18") (mounting screw: M4 screw) Not used when connecting to FX3UC Series PLC.
- [6] POWER LED (green): Lit while 5V DC power is supplied from main unit.
- [7] RD LED (red): Lit while receiving data from connected RS-232C device.
- [8] SD LED (red): Lit while sending data to connected RS-232C device.
- [9] Special adapter connector: Used to connect this special adapter to PLC main unit or special adapter.
- [10] RS-232C connector (9-pin D-Sub, male): Connect RS-232C device to this RS-232C connector
- [11] Screws to fix the cable connector: Screw holes #4-40UNC (inch screw thread)
- [12] DIN rail mounting hook
- [13] Special adapter fixing hook
- [14] Special adapter connector: Used to connect communication or analog special adapters to the left side of the 232ADP.

1.4 Pin Configuration

The pin configuration of the RS-232C port on the 232ADP is as shown below.

Pin No.	Signal	Name	Function
1	CD	Receive carrier detection	Turns ON when carrier for data transfer is detected. (RS-232C device to 232ADP)
2	RD (RXD)	Receive data	Receives data (RS-232C device to 232ADP)
3	SD (TXD)	Send data	Sends data (232ADP to RS-232C device)
4	ER (DTR)	Send request	Turns ON when RS-232C equipment becomes ready for data transfer. (232ADP to RS-232C device)
5	SG (GND)	Signal ground	Signal ground (232ADP to RS-232C device)
6	DR (DSR)	Send enable	Turns ON when send request is given to RS-232C equipment (RS-232C device to 232ADP)
7, 8, 9	Not used		Do not wire.

2. Channel Allocation

Up to two communication ports can be added to the main unit.

FX3U / FX3UC-32MT-LT(-2) Series PLC

Communication port channels are automatically allocated. The communication special adapter closer to the main unit is ch1.

- Using one communication special adapter + communication expansion board

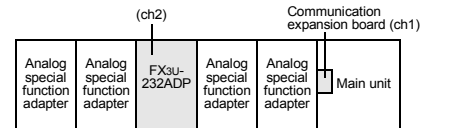

- Using two communication special adapters

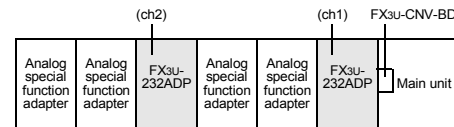

FX3UC (D, DSS) Series PLC

Communication port channels are automatically allocated. The communication special adapter closer to the main unit is ch1.

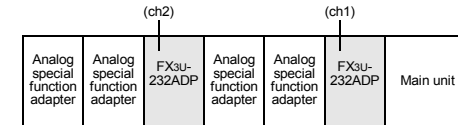

FX3G Series PLC

Communication port channels are automatically allocated.

- 40-point, 60-point type

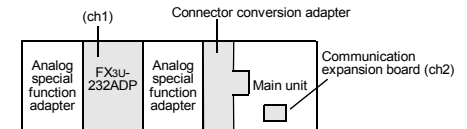

- 14-point, 24-point type

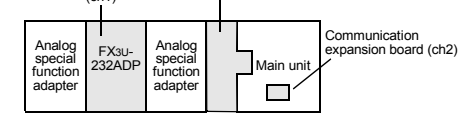

3. Installation

For installation/uninstallation details, refer to the following manuals:

- Refer to the FX3G Series User's Manual - Hardware Edition.
- Refer to the FX3U Series User's Manual - Hardware Edition.
- Refer to the FX3UC Series User's Manual - Hardware Edition.

INSTALLATION PRECAUTIONS ⚠ DANGER

- Make sure to cut off all phases of the power supply externally before attempting installation or wiring work. Failure to do so may cause electric shock or damage to the product.

INSTALLATION PRECAUTIONS ⚠ CAUTION

- Use the product within the generic environment specifications described in PLC main unit manual (Hardware Edition). Never use the product in areas with excessive dust, oily smoke, conductive dusts, corrosive gas (salt air, Cl₂, H₂S, SO₂, or NO₂), flammable gas, vibration or impacts, or expose it to high temperature, condensation, or rain and wind.
- If the product is used in such conditions, electric shock, fire, malfunctions, deterioration or damage may occur.
- When drilling screw holes or wiring, make sure cutting or wire debris does not enter the ventilation slits. Failure to do so may cause fire, equipment failures or malfunctions.
- Do not touch the conductive parts of the product directly. Doing so may cause device failures or malfunctions.
- Connect special adapter securely to their designated connectors. Loose connections may cause malfunctions.

3.1 Connection to the FX3U Series PLC

Procedure

- Turn off the power.
Disconnect all the cables connected to the PLC main unit and special adapter, and demount the main unit and special adapter mounted on DIN rail or mounted directly using screws.
- Install an expansion board to the main unit.
For the expansion board installation procedure, refer to the following manual:
→ Refer to the FX3U Series User's Manual - Hardware Edition
- Remove the special adapter connector cover on the expansion board (fig.A).
When connecting this product to another special adapter, please replace the 'expansion board' in the above description with a 'special adapter' and perform the procedure as indicated.
- Slide the special adapter slide lock (fig.B) of the main unit.
When connecting this product to another special adapter, please replace the 'main unit' in the above description with a 'special adapter' and perform the procedure as indicated.
- Connect the special adapter (fig.C) to the main unit as shown on the right.
- Slide back the special adapter slide lock (fig.B) of the main unit to fix the special adapter (fig.C).

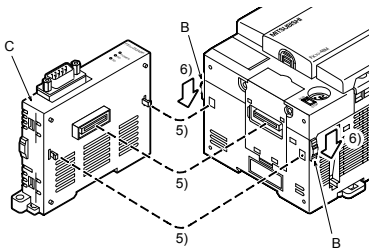
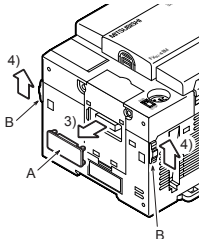

Connection precautions

Connect all the high-speed I/O special adapters before connecting other special adapters when they are used in combination.
Do not connect a high-speed I/O special adapter on the left side of a communication or analog special adapter.

3.2 Connection to the FX3uc (D, DSS) Series PLC

Procedure

- Turn off the power.
Disconnect all the cables connected to the PLC, and demount the PLC from the DIN rail.
- Remove the special adapter connector cover (fig.A).
- Slide the special adapter slide lock (fig.B) of the main unit.
When connecting this product to another special adapter, please replace the 'main unit' in the above description with a 'special adapter' and perform the procedure as indicated.
- Connect the special adapter (fig.C) to the main unit as shown on the right.
- Slide back the special adapter slide lock (fig.B) of the main unit to fix the special adapter (fig.C).

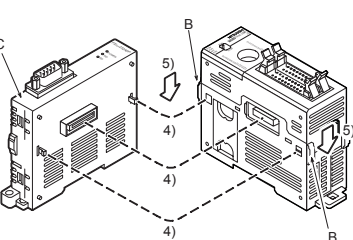
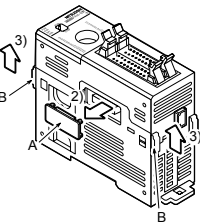

3.3 Connection to the FX3uc-32MT-LT(-2) Series PLC

→ For details, refer to the FX3uc Series User's Manual - Hardware Edition.

3.4 Connection to the FX3G Series PLC

Procedure

- Turn off the power.
Disconnect all the cables connected to the PLC, and demount the PLC from the DIN rail.
- Install a connector conversion adapter to the main unit.
For the connector conversion adapter installation procedure, refer to the following manual:
→ Refer to the FX3G Series User's Manual - Hardware Edition
- Remove the special adapter connector cover when connecting this product to another special adapter.
Removal of the special adapter connector cover is not required when connecting this product to the connector conversion adapter.
- Slide the special adapter slide lock (fig.A) of the connector conversion adapter.
When connecting this product to another special adapter, please replace the 'connector conversion adapter' in the above description with a 'special adapter' and perform the procedure as indicated.
- Connect the special adapter (fig.B) to the connector conversion adapter as shown on the right.
- Slide back the special adapter slide lock (fig.A) of the connector conversion adapter to fix the special adapter (fig.B).

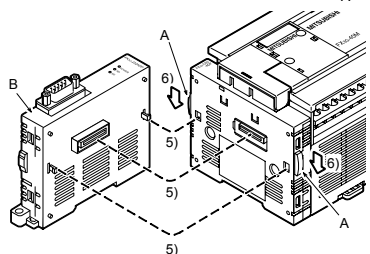
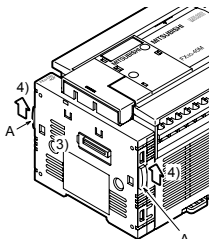

4. Wiring

For wiring details, refer to FX Series User's Manual - Data Communication Edition.

WIRING PRECAUTIONS **⚠ DANGER**

- Make sure to cut off all phases of the power supply externally before attempting installation or wiring work.
Failure to do so may cause electric shock or damage to the product.

WIRING PRECAUTIONS **⚠ CAUTION**

- Make sure to cut off all phases of the power supply externally before attempting installation or wiring work.
Failure to do so may cause electric shock or damage to the product.
- Make sure to observe the following precautions in order to prevent any damage to the machinery or accidents due to abnormal data written to the PLC under the influence of noise:
 - Do not bundle the main circuit line together with or lay it close to the main circuit, high-voltage line or load line.
Otherwise, noise disturbance and/or surge induction are likely to take place. As a guideline, lay the control line at least 100mm (3.94") or more away from the main circuit or high-voltage lines.

5. Specifications

STARTUP AND MAINTENANCE PRECAUTIONS **⚠ CAUTION**

- Do not disassemble or modify the PLC.
Doing so may cause fire, equipment failures, or malfunctions.
* For repair, contact your local Mitsubishi Electric distributor.
- Do not drop the product or exert strong impact to it.
Doing so may cause damage.

DISPOSAL PRECAUTIONS **⚠ CAUTION**

- Please contact a certified electronic waste disposal company for the environmentally safe recycling and disposal of your device.

TRANSPORT AND STORAGE PRECAUTIONS **⚠ CAUTION**

- The product is a precision instrument. During transportation, avoid any impacts.
Failure to do so may cause failures in the product. After transportation, verify the operations of the product.

5.1 Applicable PLC

Model name	Applicability
FX3U Series PLC	Ver.2.20 or later (from first production)
FX3UC Series PLC	Ver.1.00 or later (from first production)
FX3G Series PLC	Ver.1.00 or later (from first production)

The version number can be checked by monitoring D8001 as the last three digits indicate it.

5.2 General Specifications

For the general specifications, refer to the manual of the PLC main unit.
The items other than the following are equivalent to those of the PLC main unit.

Item	Specification	
Dielectric withstand voltage	500 V AC, 1 min	Conforming to JEM-1021
Insulation resistance	5MΩ or more, 500 V DC by Megger	Between terminal block and ground terminal of PLC main unit

5.3 Power Supply Specifications

Item	Specification	
Current consumption	30mA	5V DC power is supplied from the internal power supply of main unit.
	5V DC power is supplied from the internal power supply of main unit.	

5.4 Performance Specifications

Item	Specification
Transmission standard	Conforming to RS-232C
Type of isolation	Photocoupler isolation
Transmission distance	15m (49'2") or less
Connection method	9-pin D-Sub connector (male)
Number of occupied I/O points	0 point (This number is not related to the maximum number of input/output points of the PLC.)
Communication method	Full-duplex
Baud rate	Computer Link, Non-Protocol Communication: 300/600/1200/2400/4800/9600/19200/38400 ¹ bps Programming Communication: 9600/19200/38400/57600/115200bps
Communication format	Computer Link (dedicated protocol: format 1/format 4), Non-Protocol Communication, and Programming communication
LED display: LED color	Power: green, RD: red, SD: red

¹ Only the FX3G PLC supports 38400 bps.

This manual confers no industrial property rights or any rights of any other kind, nor does it confer any patent licenses. Mitsubishi Electric Corporation cannot be held responsible for any problems involving industrial property rights which may occur as a result of using the contents noted in this manual.

Warranty
Mitsubishi will not be held liable for damage caused by factors found not to be the cause of Mitsubishi; opportunity loss or lost profits caused by faults in the Mitsubishi products; damage, secondary damage, accident compensation caused by special factors unpredictable by Mitsubishi; damages to products other than Mitsubishi products; and to other duties.

⚠ For safe use

- This product has been manufactured as a general-purpose part for general industries, and has not been designed or manufactured to be incorporated in a device or system used in purposes related to human life.
- Before using the product for special purposes such as nuclear power, electric power, aerospace, medicine or passenger movement vehicles, consult with Mitsubishi Electric.
- This product has been manufactured under strict quality control. However when installing the product where major accidents or losses could occur if the product fails, install appropriate backup or failsafe functions in the system.

MITSUBISHI *Changes for the Better*
 PROGRAMMABLE CONTROLLERS
FX3U-232ADP
Installation Manual

Manual Number	JY997D13701
Revision	F
Date	September 2008

This manual describes the part names, dimensions, mounting, and specifications of the product. Before use, read this manual and the manuals of all relevant products fully to acquire proficiency in handling and operating the product. Make sure to learn all the product information, safety information, and precautions.

Store this manual in a safe place so that it can be taken out and read whenever necessary. Always forward it to the end user.

Registration:
 The company and product names described in this manual are registered trademarks or the trademarks of their respective companies.

Effective September 2008
 Specifications are subject to change without notice.
 © 2005 Mitsubishi Electric Corporation

Safety Precaution (Read these precautions before use.)
 This manual classifies the safety precautions into two categories:
⚠ DANGER and **⚠ CAUTION**.

⚠ DANGER	Indicates that incorrect handling may cause hazardous conditions, resulting in death or severe injury.
⚠ CAUTION	Indicates that incorrect handling may cause hazardous conditions, resulting in medium or slight personal injury or physical damage.

Depending on the circumstances, procedures indicated by **⚠ CAUTION** may also cause severe injury. It is important to follow all precautions for personal safety.

Associated Manuals

Manual name	Manual No.	Description
FX3G Series User's Manual - Hardware Edition	JY997D31301 MODEL CODE: 09R521	Explains the FX3G Series PLC specifications for I/O, wiring, installation, and maintenance.
FX3U Series User's Manual - Hardware Edition	JY997D16501 MODEL CODE: 09R516	Explains the FX3U Series PLC specifications for I/O, wiring, installation, and maintenance.
FX3UC Series User's Manual - Hardware Edition	JY997D28701 MODEL CODE: 09R519	Explains the FX3UC Series PLC specifications for I/O, wiring, installation, and maintenance.
FX3G/FX3U/FX3UC Series Programming Manual - Basic & Applied Instruction Edition	JY997D16601 MODEL CODE: 09R517	Describes PLC programming for basic/applied instructions and devices.
FX Series User's Manual - Data Communication Edition	JY997D16901 MODEL CODE: 09R715	Explains N:N network, Parallel Link, Computer Link, Non-Protocol communication by RS and RS2 instructions/FX2N-232IF.

How to obtain manuals
 For product manuals or documents, consult with the Mitsubishi Electric dealer from who you purchased your product.

Applicable standards
 FX3U-232ADP units made in June, 2005 or later comply with the EC Directive (EMC Directive) and UL standards (UL, cUL). Further information can be found in the following manual.
 → Refer to the **FX3G Series Hardware Manual (Manual No. JY997D33401)**
 → Refer to the **FX3U Series Hardware Manual (Manual No. JY997D18801)**
 → Refer to the **FX3UC (D, DSS) Series Hardware Manual (Manual No. JY997D28601)**
 → Refer to the **FX3UC-32MT-LT-2 Hardware Manual (Manual No. JY997D31601)**
 Regarding the standards that relate to the main unit, please refer to either the FX series product catalog or consult with your nearest Mitsubishi product provider.

1. Outline
 The FX3U-232ADP communication special adapter (hereinafter called 232ADP) is a special adapter for RS-232C communication with a 9-pin D-Sub connector. The 232ADP is an isolated signal exchange unit used for RS-232C serial data communication between the PLC and an RS-232C device.

1.1 Communication Function

Communication type	Function
Computer link	Data transfer between the PLC and computer (specified as the master station) via dedicated protocol.
Non-protocol communication	Serial communication between the PLC and an RS-232C device via non-protocol.
Programming communication	Program transfer or monitoring enabled via the serial port of the 232ADP.
Remote maintenance	Program transfer or monitoring enabled via modem and phone line connected to the serial port of the 232ADP.

1.2 Incorporated Items
 Verify that the following product and items are included in the package:

Product Manual

Weight: Approx. 80g (0.18 lbs)

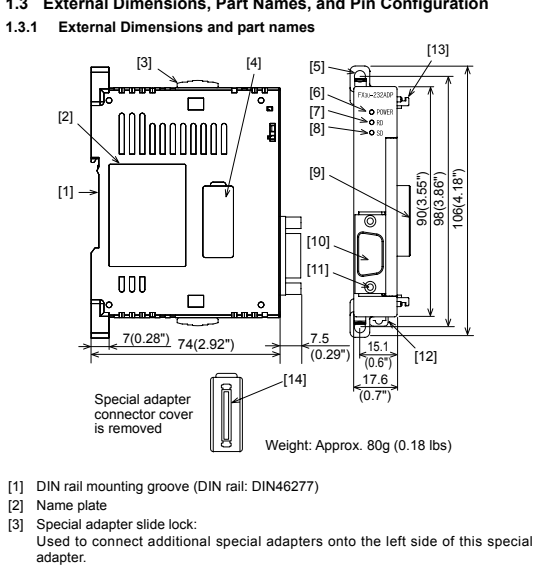

- Special adapter connector cover: Remove this cover to connect additional special adapters to the left side.
- Direct mounting hole: 2 holes of $\phi 4.5$ (0.18") (mounting screw: M4 screw) Not used when connecting to FX3UC Series PLC.
- POWER LED (green): Lit while 5V DC power is supplied from main unit.
- RD LED (red): Lit while receiving data from connected RS-232C device.
- SD LED (red): Lit while sending data to connected RS-232C device.
- Special adapter connector: Used to connect this special adapter to PLC main unit or special adapter.
- RS-232C connector (9-pin D-Sub, male): Connect RS-232C device to this RS-232C connector
- Screws to fix the cable connector: Screw holes #4-40UNC (inch screw thread)
- DIN rail mounting hook
- Special adapter fixing hook
- Special adapter connector: Used to connect communication or analog special adapters to the left side of the 232ADP.

1.4 Pin Configuration
 The pin configuration of the RS-232C port on the 232ADP is as shown below.

Pin No.	Signal	Name	Function
1	CD	Receive carrier detection	Turns ON when carrier for data transfer is detected. (RS-232C device to 232ADP)
2	RD (RXD)	Receive data	Receives data (RS-232C device to 232ADP)
3	SD (TXD)	Send data	Sends data (232ADP to RS-232C device)
4	ER (DTR)	Send request	Turns ON when RS-232C equipment becomes ready for data transfer. (232ADP to RS-232C device)
5	SG (GND)	Signal ground	Signal ground (232ADP to RS-232C device)
6	DR (DSR)	Send enable	Turns ON when send request is given to RS-232C equipment (RS-232C device to 232ADP)
7,8,9	Not used	Do not wire.	

2. Channel Allocation
 Up to two communication ports can be added to the main unit.

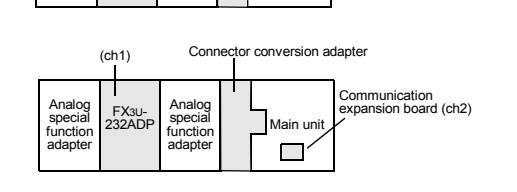
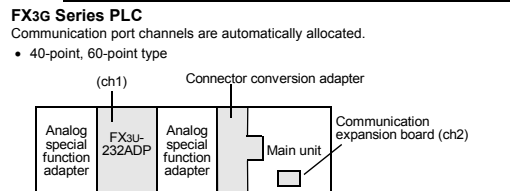
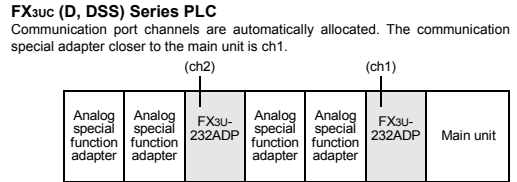
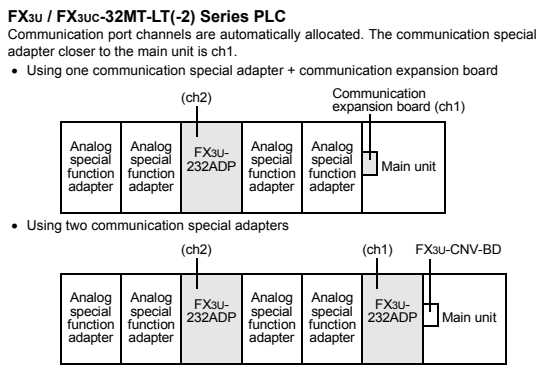

3. Installation
 For installation/uninstallation details, refer to the following manuals:
 → Refer to the **FX3G Series User's Manual - Hardware Edition**.
 → Refer to the **FX3U Series User's Manual - Hardware Edition**.
 → Refer to the **FX3UC Series User's Manual - Hardware Edition**.

INSTALLATION PRECAUTIONS **⚠ DANGER**

- Make sure to cut off all phases of the power supply externally before attempting installation or wiring work. Failure to do so may cause electric shock or damage to the product.

INSTALLATION PRECAUTIONS **⚠ CAUTION**

- Use the product within the generic environment specifications described in PLC main unit manual (Hardware Edition). Never use the product in areas with excessive dust, oily smoke, conductive dusts, corrosive gas (salt air, Cl₂, H₂S, SO₂, or NO₂), flammable gas, vibration or impacts, or expose it to high temperature, condensation, or rain and wind. If the product is used in such conditions, electric shock, fire, malfunctions, deterioration or damage may occur.
- When drilling screw holes or wiring, make sure cutting or wire debris does not enter the ventilation slits. Failure to do so may cause fire, equipment failures or malfunctions.
- Do not touch the conductive parts of the product directly. Doing so may cause device failures or malfunctions.
- Connect special adapter securely to their designated connectors. Loose connections may cause malfunctions.

3.1 Connection to the FX3U Series PLC

Procedure

- Turn off the power. Disconnect all the cables connected to the PLC main unit and special adapter, and demount the main unit and special adapter mounted on DIN rail or mounted directly using screws.
- Install an expansion board to the main unit. For the expansion board installation procedure, refer to the following manual:
 → Refer to the **FX3U Series User's Manual - Hardware Edition**
- Remove the special adapter connector cover on the expansion board (fig.A). When connecting this product to another special adapter, please replace the 'expansion board' in the above description with a 'special adapter' and perform the procedure as indicated.
- Slide the special adapter slide lock (fig.B) of the main unit. When connecting this product to another special adapter, please replace the 'main unit' in the above description with a 'special adapter' and perform the procedure as indicated.
- Connect the special adapter (fig.C) to the main unit as shown on the right.
- Slide back the special adapter slide lock (fig.B) of the main unit to fix the special adapter (fig.C).

Connection precautions
 Connect all the high-speed I/O special adapters before connecting other special adapters when they are used in combination. Do not connect a high-speed I/O special adapter on the left side of a communication or analog special adapter.

3.2 Connection to the FX3UC (D, DSS) Series PLC

Procedure

- Turn off the power. Disconnect all the cables connected to the PLC, and demount the PLC from the DIN rail.
- Remove the special adapter connector cover (fig.A).
- Slide the special adapter slide lock (fig.B) of the main unit. When connecting this product to another special adapter, please replace the 'main unit' in the above description with a 'special adapter' and perform the procedure as indicated.
- Connect the special adapter (fig.C) to the main unit as shown on the right.
- Slide back the special adapter slide lock (fig.B) of the main unit to fix the special adapter (fig.C).

3.4 Connection to the FX3G Series PLC

Procedure

- Turn off the power. Disconnect all the cables connected to the PLC, and demount the PLC from the DIN rail.
- Install a connector conversion adapter to the main unit. For the connector conversion adapter installation procedure, refer to the following manual:
 → Refer to the **FX3G Series User's Manual - Hardware Edition**
- Remove the special adapter connector cover when connecting this product to another special adapter. Removal of the special adapter connector cover is not required when connecting this product to the connector conversion adapter.
- Slide the special adapter slide lock (fig.A) of the connector conversion adapter. When connecting this product to another special adapter, please replace the 'connector conversion adapter' in the above description with a 'special adapter' and perform the procedure as indicated.
- Connect the special adapter (fig.B) to the connector conversion adapter as shown on the right.
- Slide back the special adapter slide lock (fig.A) of the connector conversion adapter to fix the special adapter (fig.B).

4. Wiring
 For wiring details, refer to FX Series User's Manual - Data Communication Edition.

WIRING PRECAUTIONS **⚠ DANGER**

- Make sure to cut off all phases of the power supply externally before attempting installation or wiring work. Failure to do so may cause electric shock or damage to the product.

WIRING PRECAUTIONS **⚠ CAUTION**

- Make sure to cut off all phases of the power supply externally before attempting installation or wiring work. Failure to do so may cause electric shock or damage to the product.
- Make sure to observe the following precautions in order to prevent any damage to the machinery or accidents due to abnormal data written to the PLC under the influence of noise:
 - Do not bundle the main circuit line together with or lay it close to the main circuit, high-voltage line or load line.
 - Otherwise, noise disturbance and/or surge induction are likely to take place. As a guideline, lay the control line at least 100mm (3.94") or more away from the main circuit or high-voltage lines.

5. Specifications

STARTUP AND MAINTENANCE PRECAUTIONS **⚠ CAUTION**

- Do not disassemble or modify the PLC. Doing so may cause fire, equipment failures, or malfunctions. * For repair, contact your local Mitsubishi Electric distributor.
- Do not drop the product or exert strong impact to it. Doing so may cause damage.

DISPOSAL PRECAUTIONS **⚠ CAUTION**

- Please contact a certified electronic waste disposal company for the environmentally safe recycling and disposal of your device.

TRANSPORT AND STORAGE PRECAUTIONS **⚠ CAUTION**

- The product is a precision instrument. During transportation, avoid any impacts. Failure to do so may cause failures in the product. After transportation, verify the operations of the product.

5.1 Applicable PLC

Model name	Applicability
FX3U Series PLC	Ver.2.20 or later (from first production)
FX3UC Series PLC	Ver.1.00 or later (from first production)
FX3G Series PLC	Ver.1.00 or later (from first production)

The version number can be checked by monitoring D8001 as the last three digits indicate it.

5.2 General Specifications
 For the general specifications, refer to the manual of the PLC main unit. The items other than the following are equivalent to those of the PLC main unit.

Item	Specification
Dielectric withstand voltage	500 V AC, 1 min Conforming to JEM-1021 Between terminal block and ground terminal of PLC main unit
Insulation resistance	5MΩ or more, 500 V DC by Megger

5.3 Power Supply Specifications

Item	Specification
Current consumption	30mA 5V DC power is supplied from the internal power supply of main unit.

5.4 Performance Specifications

Item	Specification
Transmission standard	Conforming to RS-232C
Type of isolation	Photocoupler isolation
Transmission distance	15m (49'2") or less
Connection method	9-pin D-Sub connector (male)
Number of occupied I/O points	0 point (This number is not related to the maximum number of input/output points of the PLC.)
Communication method	Full-duplex
Baud rate	Computer Link, Non-Protocol Communication: 300/600/1200/2400/4800/9600/19200/38400 ¹ bps Programming Communication: 9600/19200/38400/57600/115200bps
Communication format	Computer Link (dedicated protocol: format 1/format 4), Non-Protocol Communication, and Programming communication
LED display: LED color	Power: green, RD: red, SD: red

¹ Only the FX3G PLC supports 38400 bps.

This manual confers no industrial property rights or any rights of any other kind, nor does it confer any patent licenses. Mitsubishi Electric Corporation cannot be held responsible for any problems involving industrial property rights which may occur as a result of using the contents noted in this manual.

Warranty
 Mitsubishi will not be held liable for damage caused by factors found not to be the cause of Mitsubishi; opportunity loss or lost profits caused by faults in the Mitsubishi products; damage, secondary damage, accident compensation caused by special factors unpredictable by Mitsubishi; damages to products other than Mitsubishi products; and to other duties.

For safe use

- This product has been manufactured as a general-purpose part for general industries, and has not been designed or manufactured to be incorporated in a device or system used in purposes related to human life.
- Before using the product for special purposes such as nuclear power, electric power, aerospace, medicine or passenger movement vehicles, consult with Mitsubishi Electric.
- This product has been manufactured under strict quality control. However when installing the product where major accidents or losses could occur if the product fails, install appropriate backup or failsafe functions in the system.